

# nifty

## 120T/TM34T

Operating and Safety Instructions

**MODEL 120T (TM34T) SERIES**

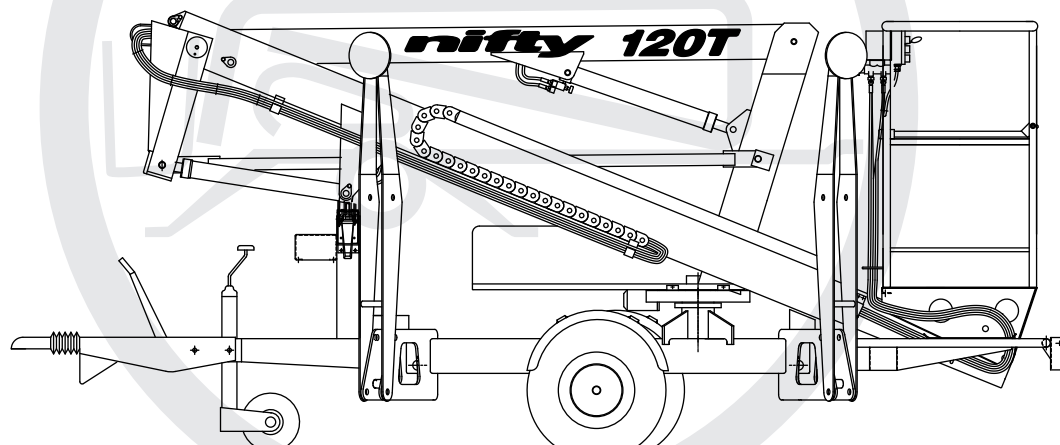

**niftylift.com**  
info@niftylift.com

M50121/06



### **Niftylift Limited**

Fingle Drive  
Stonebridge  
Milton Keynes  
MK13 0ER  
England

www.niftylift.com  
e-mail: info@niftylift.com  
Tel: +44 (0)1908 223456  
Fax: +44 (0)1908 312733



# Table of Contents

<b>1</b>	<b>INTRODUCTION AND GENERAL INFORMATION</b>	<b>PAGE</b>
1.1	Foreword	2
1.2	Scope	3
1.3	Introducing the 120T Trailer Mount (TM) Series	3
1.4	General Specification	4
1.5	Identification	5-6
1.6	EC Declaration of Conformity	7
<b>2</b>	<b>SAFETY</b>	
2.1	Mandatory Precautions	7-10
2.2	Environmental Limitations	11
2.3	Noise & Vibration	11
2.4	Test Report	11
<b>3</b>	<b>PREPARATION AND INSPECTION</b>	
3.1	Unpacking	12
3.2	Preparation for Use	12
3.3	Pre-Operational Safety Check Schedules	13-14
3.4	Placard, Decals and Installation	15-20
3.5	Torque Requirements	21
<b>4</b>	<b>OPERATION</b>	
4.1	Control Circuit Components	22
4.2	Setting Up Procedures	23
4.3	Ground Control Operation	24-25
4.4	Platform Control Operation	26-27
4.5	Cage Weigh System	28-30
4.6	Batteries and Charging	31-32
4.7	Transporting, Towing, Craneage, Storage and Setting to Work	33-36
4.8	Traction Drive	37-38
<b>5</b>	<b>EMERGENCY CONTROLS</b>	
5.1	General	39
5.2	Emergency Procedures - Incapacitated Operator	39
5.3	Emergency Procedures - Machine Failure	39
5.4	Incident Notification	39
<b>6</b>	<b>RESPONSIBILITIES</b>	
6.1	Changes in Ownership	40
6.2	Manual of Responsibilities (USA only)	40
6.3	Inspection/ Service Check List	41-42

# 1 Introduction and General Information

## 1.1 FOREWORD

The purpose of these manuals is to provide the customer with appropriate safety operating and maintenance instructions essential for proper machine operation.

All information in these manuals should be **READ** and fully **UNDERSTOOD** before any attempt is made to operate the machine. **THESE MANUALS ARE VERY IMPORTANT TOOLS** - Keep them with the machine at all times.

**The manufacturer has no direct control over machine application and use, therefore conformance with good safety practices is the responsibility of the user and his operating personnel.**

**All information in these manuals is based on the use of the machine under proper operating conditions. Alteration and/or modification of the machine are strictly forbidden.**

**One of the most important facts to remember is that any equipment is only as safe as those who operate it.**

### **DANGER, WARNING, CAUTION, IMPORTANT, INSTRUCTIONS AND NOTICE**

Any place these topics may appear, either in this manual or on the machine, they are defined as follows:

**DANGER:** If not correctly followed there is a high probability of serious injury or death to personnel.

**WARNING OR CAUTION:** If not correctly followed there is some possibility of serious injury or death to personnel.



THE '**SAFETY ALERT**' SYMBOL IS USED TO CALL ATTENTION TO POTENTIAL HAZARDS THAT MAY LEAD TO SERIOUS INJURY OR DEATH, IF IGNORED.

**IMPORTANT AND INSTRUCTIONS:** Denotes procedures essential to safe operation and prevention of damage to or destruction of the machine.

**NOTICE:** Indicates general safety rules and/or procedures relating to the machine.

**It is the owner's/user's responsibility to know and comply with all applicable rules, regulations, laws, codes and any other requirements applicable to the safe use of this equipment.**

## 1.2 SCOPE

These operating instructions contain all the necessary information required to allow the safe operation of any Niftylift 120T (TM34T), powered by electric (DC), diesel (D), petrol/gasoline (P) engine, or a combination of these.

For further technical information, circuit diagrams and specific instructions for all maintenance which may need to be carried out by specialist trained personnel, see the associated Workshop and Parts manual for your model of Niftylift 120T (TM34T).

## 1.3 INTRODUCING THE 120T TRAILER MOUNT (TM) SERIES

Please note at the time of going to press all information, illustrations, details and descriptions contained herein are valid. Niftylift reserves the right to change, modify or improve its products without any obligations to install them on previously manufactured machines.

If you require further information after reading this manual, please do not hesitate to contact us.

**Niftylift Ltd, Fingle Drive, Stonebridge, Milton Keynes MK13 0ER, Great Britain**

**Tel: +44 (0) 1908 223456 Fax: +44 (0) 1908 312733**

**Niftylift Inc, 32 Concourse Way, Greer, SC 29651 USA**

**Tel: +01 864 968 8881 Fax: +01 864 968 8836**

**Nifty Pty Ltd, 11 Kennington Drive, Tomago, NSW 2322, Australia**

**Tel: +61 (0) 2 4964 9765 Fax: +61 (0) 2 4964 9714**

The Niftylift 120T trailer mount is an extremely versatile articulated boom platform of unique and simple design. It is capable of placing two men and their tools up to a height of 12.20m (40ft) or an outreach of 6.10m (20ft 1in).

The booms are mounted via a 360<sup>0</sup> powered swing mechanism on to a compact base balanced on a single axle. The fully articulating booms give an outstanding working envelope. The large pneumatic wheels and minimal weight make the unit light and simple to manoeuvre.

A simple, all-hydraulic proportional control system gives smooth, reliable movement of the platform and maximum reliability in the harshest environments.

The hydraulic outriggers make setting up both swift and simple and a unique pressure sensitive microswitch system fitted to each outrigger prevents operation of the machine until all outriggers have been correctly deployed. This is coupled with a loud audible alarm warning of a possibly hazardous situation.

*Models include the following:*

E: - DC ELECTRIC

BE: - BI-ENERGY (DIESEL & BATTERY)

AC: - AC ELECTRIC

PE: - BI-ENERGY (PETROL & BATTERY)

D: - DIESEL

P: - PETROL

A: - AIR

**Operating & Safety Instructions****1.4 GENERAL SPECIFICATION**

<b>FEATURE</b>	<b>120T (TM34T)</b>
MAXIMUM HEIGHT - WORKING	12.2m 40ft
MAXIMUM HEIGHT - PLATFORM	10.2m 34ft
MAXIMUM HEIGHT - STOWED	1.9m 6ft 3in
MAXIMUM OUTREACH	6.1m 20ft 1in
MAXIMUM WIDTH - TOWING	1.5m 4ft 11in
JACK SPREAD	3.55m 11ft 8in
MAXIMUM LENGTH - STOWED	4.45m 14ft 7in
MAXIMUM CAPACITY - (EUROPEAN) (USA)	200kg (440lbs) 500lb
TURRET ROTATION	360°
TURRET TAIL SWING	Zero
MAXIMUM TRAVEL SPEED	45 mph 72 kph
PLATFORM SIZE - LENGTH X WIDTH	0.65m x 1.1m 25in x 44in
CONTROLS	Full proportional hydraulic
HYDRAULIC PRESSURE	200bar 2,900 psi
TYRES	165 R14 C8      175 R14C 8PR (Traction Drive) 4.5 bar (65 psi)
GROUND CLEARANCE	26cm 10½in
GROSS VEHICLE WEIGHT (MAXIMUM)	1300kg 2860lb
MAXIMUM GROUND PRESSURE	0.06kn/cm <sup>2</sup> 12500lb/ft <sup>2</sup>
POWER SOURCE	E (Electric) models - 4 x 6v 250 AH batteries P (G) (Petrol/Gasoline) models - Honda GX160 Engine D (Diesel) models - Yanmar L40 or Kubota OC60 engine

## 1.5 IDENTIFICATION (UK PLATE)

			
NIFTYLIFT LTD. FINGLE DRIVE, STONEBRIDGE MILTON KEYNES MK13 0ER ENGLAND TEL 01908 223456 : FAX 01908 312733 e-mail : info@niftylift.com			
SERIAL No			
TYPE			
YEAR OF MANUFACTURE			
WEIGHT			kg
RATED LOAD	PERSONS	+	kg
MAXIMUM SAFE WORKING LOAD			kg
MAXIMUM PULL			N
MAXIMUM WIND SPEED			m/s
MAX. ALLOWABLE INCLINATION			Deg.
MAXIMUM HYDRAULIC PRESSURE			bar
MAXIMUM VOLTAGE			V
AMPS			A
ELEC. CCT D	ISSUE		
HYD. CCT D	ISSUE		
			P10805

**This manufacturer's plate is attached to Boom 1 on each machine at the time of manufacture on every Niftylift. Please ensure all sections have been stamped and are legible.**

**1.5a IDENTIFICATION (USA PLATE)**

	
NIFTYLIFT LTD. FINGLE DRIVE, STONEBRIDGE MILTON KEYNES MK13 0ER GREAT BRITAIN TEL (01144)1908 223456 : FAX (01144) 1908 312733 e-mail : info@niftylift.com	
THIS WORK PLATFORM COMPLIES WITH ANSI STANDARD A 92-	
MODEL	
SERIAL NO	
YEAR OF MANUFACTURE	
CAPACITY RATING	LBS
PLATFORM HEIGHT	FEET
GROSS WEIGHT	LBS
MAXIMUM HYDRAULIC PRESSURE	PSI
MAXIMUM VOLTAGE	V
AMPS	A
ELEC. CCT D	ISSUE
HYD. CCT D	ISSUE
P11497	

**This manufacturer's plate is attached to Boom 1 on each machine at the time of manufacture on every Niftylift. Please ensure all sections have been stamped and are legible.**



## 1.6 EC DECLARATION OF CONFORMITY (Typical)



---

---

### EC DECLARATION OF CONFORMITY

---

---

MANUFACTURER AND PERSON RESPONSIBLE FOR DOCUMENTATION: **NIFTYLIFT LTD  
MALCOLM NORTH**

ADDRESS: **FINGLE DRIVE,  
STONEBRIDGE,  
MILTON KEYNES,  
MK13 0ER,  
ENGLAND.**

MACHINE TYPE: MOBILE ELEVATING WORK PLATFORM

MODEL TYPE:

SERIAL NUMBER:

NOTIFIED BODY: RWTUV Anlagentechnik GmbH

NOTIFIED BODY NUMBER: 0044

ADDRESS: POSTFACH 10 32 61  
D-45141 ESSEN  
GERMANY

CERTIFICATE NUMBER:

APPLICABLE STANDARDS: EN 280:2001+A2:2009  
DIN EN 60204-1, 2006/42/EC

*We hereby declare that the above mentioned machine conforms with the requirements of the Machinery Directive, 2006/42/EC and EMC Directive 2004/108/EC*

SIGNED:  DATE: 14<sup>th</sup> December 2009

NAME: Malcolm North POSITION: Engineering Manager

**NOTE:**

THIS DECLARATION CONFORMS WITH THE REQUIREMENTS OF ANNEX II-1.A OF THE COUNCIL DIRECTIVE 2006/42/EC. ANY MODIFICATIONS TO THE ABOVE MENTIONED MACHINE WILL INVALIDATE THIS DECLARATION, AND THE MACHINE'S APPROVAL.

## **2 Safety**

### **2.1 MANDATORY PRECAUTIONS**

When operating your Niftylift, your safety is of utmost concern. In order to fully appreciate all aspects of the machines operation it should be ensured that each operator has **READ** and fully **UNDERSTOOD** the relevant manual covering machine use, maintenance and servicing. If any doubts exist concerning any points covered in your manual, contact your local dealer or Niftylift Ltd.

Before using any Niftylift, thoroughly inspect the machine for damage or deformation to all major components. Likewise, check the control systems for hydraulic leaks, damaged hoses, cable faults or loose covers to electrical components. At no time should damaged or faulty equipment be used - Correct all defects before putting the platform to work. If in doubt, contact your local dealer or Niftylift Ltd (see front cover for address).



**THE MANUFACTURER HAS NO DIRECT CONTROL OVER THE MACHINE APPLICATION AND USE. THEREFORE CONFORMANCE WITH GOOD SAFETY PRACTICES IS THE RESPONSIBILITY OF THE USER AND HIS OPERATING PERSONNEL. FAILURE TO UNDERSTAND AND FOLLOW ALL SAFETY RULES COULD RESULT IN SERIOUS INJURY OR DEATH.**

- 2.1.1** Only trained persons will be permitted to operate the Niftylift.
- 2.1.2** Always operate the Niftylift in full accordance with the manufacturers Operating & Safety Instructions for that model.
- 2.1.3** Before use each day and at the beginning of each shift the Niftylift shall be given a visual inspection and functional test including, but not limited to, operating and emergency controls, safety devices, personal protective clothing, including fall protection, air, hydraulic and fuel system leaks, cables and wiring harness, loose or missing parts, tyres and wheels, placards, warnings, control markings and Operating and Safety Manuals, guards and guard rail systems and all other items specified by the manufacturer.
- 2.1.4** Any problems or malfunctions that affect operational safety must be repaired prior to use of the platform, with specific regard to any safety components refer to the Parts Manual for part numbers and details. If in doubt, contact Niftylift Ltd (Details on page 3).
- 2.1.5** Always ensure that all warning labels, instructions, placards, control markings and Safety Manuals are intact and clearly legible. If replacements are required contact your local dealer or Niftylift. Always observe and obey safety and operating instructions on such labels.
- 2.1.6** Do not alter, modify or disable in any way the controls, safety devices, interlocks or any other part of the machine.
- 2.1.7** Before the Niftylift is used and during use the user shall check the area in which it is to be used for possible hazards such as, but not limited to, uneven ground drop-offs, holes, bumps, obstructions, debris, floor and overhead obstructions, high voltage conductors, wind and weather, unauthorised persons and any other possibly hazardous conditions.

- 2.1.8** Never exceed the maximum platform capacity, as indicated on the decals and machine serial plate.
- 2.1.9** Never position any part of the Niftylift within 4.0m, (12ft) of any electrical power line, conductor or similar not exceeding 66kV. (Minimum span 125m) Other distances for increased voltages and different spans are given in NZECP 34:1993

**THIS MACHINE IS NOT INSULATED.**

If in doubt, contact the appropriate authorities.

- 2.1.10** On entering the platform, ensure that the drop down entry bar is closed afterwards.
- 2.1.11** Use of an approved safety belt and lanyard, hardhat and appropriate safety clothing is mandatory. Fasten harness to designated harness securing points within the platform and do not remove until leaving the platform whilst in the stowed position.
- 2.1.12**  Always remain standing within the platform. Do not attempt to increase your height or reach by standing and/or climbing on the platform guardrails or any other object. **KEEP YOUR FEET ON THE PLATFORM FLOOR.** Do not sit, stand or climb on the guardrail, mid rail or boom linkage. Use of planks, ladders or any other devices on the Niftylift for achieving additional height or reach shall be prohibited.
- 2.1.13** Do not use the platform levelling system to artificially increase the outreach of the platform. Never use boards or ladders in the platform to achieve the same result.
- 2.1.14** Do not use the platform to lift overhanging or bulky items that may exceed the maximum capacity or carry objects that may increase the wind loading on the platform. (e.g. Notice boards etc.)
- 2.1.15** The Niftylift shall not be operated from a position on trucks, trailers, railway cars, floating vessels, scaffolds or similar equipment unless Niftylift Ltd in Great Britain approves the application in writing.
- 2.1.16** Always check the area below and around the platform before lowering or slewing to ensure that it is clear of personnel and obstructions. Care should be taken when slewing out into areas where there may be passing traffic. Use barriers to control traffic flow or prevent access to the machine.
- 2.1.17** Stunt driving and horseplay, on or around the Niftylift, shall not be permitted.
- 2.1.18** When other moving equipment and vehicles are present, special precautions shall be taken to comply with local ordinances or safety standards established for the work place. Warnings such as, but not limited to, flags, roped off areas, flashing lights and barricades shall be used.
- 2.1.19** It shall be the responsibility of the user to determine the hazard classification of any particular atmosphere or location. Aerial platforms operated in hazardous locations shall be approved and of the type required. (For the USA refer to ANSI/NFPA 505-1987.)
- 2.1.20** The operator shall immediately report to his supervisor any potentially hazardous location(s) (environment) which become evident during operation.
- 2.1.21** If an operator encounters any suspected malfunction of the Niftylift or any hazard or potentially unsafe condition relating to capacity, intended use or safe operation he shall cease operation of the Niftylift and request further information as to safe operation from his management, or owner, dealer or manufacturer before further operation of the Niftylift.

### **Operating & Safety Instructions**

- 2.1.22** The operator shall immediately report to his superior any problems or malfunctions of the Niftylift, which becomes evident during operation. Any problems or malfunctions that affect the safety of operation shall be repaired prior to continued use.
- 2.1.23** The boom and platform of the Niftylift shall not be used to jack the wheels off the ground.
- 2.1.24** The Niftylift shall not be used as a crane.
- 2.1.25** The Niftylift shall not be positioned against another object to steady the platform.
- 2.1.26** Care should be taken to prevent rope, electric cords and hoses from becoming entangled in the aerial platform.
- 2.1.27** Batteries shall be recharged in a well-ventilated area free of flame, sparks or other hazards that may cause explosion. Highly explosive hydrogen gas is produced during the charging process.
- 2.1.28** When checking electrolyte levels, great care should be taken to protect eyes, skin and clothing. Battery acid is highly corrosive and protective glasses and clothing is recommended.
- 2.1.29**



When the machine is not in use always stow the booms correctly. **NEVER LEAVE THE KEYS IN THE MACHINE**, if it is to be left for any period of time. Use wheel chocks if leaving on an incline.

- 2.1.30** If the platform or elevating assembly becomes caught, snagged or otherwise prevented from normal motion by adjacent structure or other obstacles, such that control reversal does not free the platform, all personnel shall be removed from the platform safely before attempts are made to free the platform using ground controls.
- 2.1.31** The engine must be shut down while fuel tanks are being filled. Fuelling must be done in a well-ventilated area free of flame, sparks or any other hazard that may cause fire or explosion. **PETROL (GASOLINE), LIQUID PROPANE AND DIESEL FUELS ARE FLAMMABLE.**

**2.1.32**



**NEVER START THE NIFTYLIFT IF YOU SMELL PETROL (GASOLINE), LIQUID PROPANE OR DIESEL FUEL. THESE FUELS ARE HIGHLY FLAMMABLE**

- 2.1.33** The operator shall implement means provided to protect against use by unauthorised persons.
- 2.1.34** Never remove anything that may affect the stability of the machine such as, but not limited to, batteries, covers, engines, tyres or ballast.

## 2.2 ENVIRONMENTAL LIMITATIONS

All Niftylift Trailer Mounts are limited to operation as previously described and any slopes must be adjusted by use of the outriggers and jacks. Unless specifically configured otherwise, the machine will have short time rating for operation in extreme temperatures, i.e. reduced battery cycle times for low temperatures such as freezers, food storage etc. and cooling limitations for high temperatures as oil temperature must remain between -23° and 93° Celsius.

Extended operation in dusty environments is not recommended and frequent cleaning will be necessary. All dust, dirt, salt encrustation, excess oil or grease should be removed. Deposits of paint or bitumen, particularly on legends or labels should also be removed.

All standard Niftylift machines are rated for a wind speed of 12.5 m/s, which equates to 45kph / 28mph or force 6 on the Beaufort scale. No attempt should be made to operate a Niftylift in wind strengths above this limit and if the operator has any doubts over the wind speed he / she should cease operation immediately until it can be established that the wind speed has fallen to a safe level.



**DO NOT USE THE NIFTYLIFT IN ELECTRICAL STORMS**

## 2.3 NOISE AND VIBRATION

The airborne noise emission on the 120T range of machines does not exceed 73dB(A), measured at a perpendicular distance of 4m, under equivalent continuous A-weighted sound pressure test conditions. This was based on a Diesel powered machine, working under load. All other models will exhibit significantly lower emissions than this figure, dependant on power option.

In normal operation the Vibration level to which the operator is subjected will not exceed a weighted root mean square acceleration value of 2.5 m/s<sup>2</sup>.

## 2.4 TEST REPORT

All Niftylift machine models are subjected to a comprehensive 'type test' which duplicates all combinations of safe working load (SWL), overload, windage, inertia and pull force to assess the various safe stability criteria. Self propelled machines are also subjected to kerb and braking tests at the SWL to satisfy additional 'worse case' stability requirements.

Each individual machine is then subjected to static overload tests on flat level ground with 150% of the SWL, exceeding the requirements of EN280 for power operated MEWPs. Self propelled machines are also tested at the maximum working angle **plus** 0.5° with a test load of 125% of the SWL. Finally, on all machines, a functional test is performed with 110% of SWL.

All safety devices are checked for correct operation, operating speeds are checked against benchmark figures and the dynamic functions ensure that all acceleration and deceleration forces are within acceptable limits. All noted defects are rectified and recorded before the machine is permitted to enter into service.

## **3 Preparation and Inspection**

### **3.1 UNPACKING**

Since the manufacturer has no direct control over the shipping or carriage of any Niftylift it is the responsibility of the dealer and/or owner and/or hirer to ensure the Niftylift has not been damaged in transit and a Pre-operational Report has been carried out by a qualified engineer before the aerial platform is put into service.

- A) Remove all ropes, straps and or chains used to secure the aerial platform during transit.
- B) Ensure any ramp, loading dock or forklift used is capable of supporting or lifting the aerial platform.

**\*\*\*Carry out the Pre-operational Report before placing machine in service.**

### **3.2 PREPARATION FOR USE**

Whilst every effort has been made at the Niftylift factory to ensure your machine arrives in a safe and operable condition it is necessary to carry out a systematic inspection prior to putting the aerial platform into service.



**THIS IS NOT A REQUEST IT IS MANDATORY**

To assist the user in this task you will find enclosed an Inspection Check List (see section 6.3), which must be filled out upon delivery/receipt of the machine.

Before the user carries out the Inspection Check List he must have read and fully understood all the contents of the Operating, Safety and Maintenance Manual.



**WARNING - DO NOT OPERATE A POTENTIALLY DEFECTIVE OR MALFUNCTIONING MACHINE. CORRECT AND REPAIR ANY DEFECTS BEFORE OPERATING YOUR NIFTYLIFT.**

### **3.3 PRE-OPERATIONAL SAFETY CHECK SCHEDULES**

Before use at the beginning of the work shift, the aerial platform shall be given a visual inspection and functional tests including, but not limited to the following. It is recommended that these be performed at regular intervals as indicated on each checklist.

#### **3.3.1 DAILY SAFETY CHECKS**

- 1) Check that all labels (decals) are in place and legible.
- 2) Visually inspect the machine for damaged or loose components.
- 3) Check that batteries are charged (i.e. Charger has a solid green light and a pulsing red light).
- 4) Check the fuel level (if applicable).
- 5) Check that canopies/covers and guards are in place and secure.
- 6) Check that the boom rest switch is operable (if applicable).
- 7) Check that control levers are secure and operate freely.
- 8) Check that operating buttons and emergency stop buttons function properly.
- 9) Check the operation of the emergency hand pump.
- 10) Visually inspect all hydraulic hoses and fittings for damage or leaks.
- 11) Check operation of the stabiliser alarm.
- 12) Check that outrigger footpads are secure.
- 13) Check that the platform pivot pins and their tag bolts are secure.
- 14) Check security and operation of the boom clamp.
- 15) Check the operation of the cage weigh system (If fitted).

#### **3.3.2 WEEKLY SAFETY CHECKS**

- 1) Inspect tyres and wheels for damage and wear.
- 2) Check tyres for correct pressure. 65psi (4.5 bar)
- 3) Check mudguards for security and damage.
- 4) Check battery fluid levels and specific gravity (after charging) and general condition.
- 5) Check hydraulic oil level, ISO Grade 22 (Europe), Grade 32 (Rest of World).
- 6) Inspect the engine air filter and clean or replace if necessary.
- 7) Check that the tow hitch ball lock, breakaway cable/chain and jockey wheel are secure.
- 8) Check operation and security of stabiliser micro switches in conjunction with the alarm system.
- 9) Inspect hose track for damage or missing parts.

## **Operating & Safety Instructions**

### **3.3.3 MONTHLY SAFETY CHECKS**

- 1) Check the engine oil level (if applicable).
- 2) Check the wheel nuts (torque 80ft lbs/110Nm or 110ft lbs/150Nm Traction Drive Option).
- 3) Check outriggers for condition, security and operation.
- 4) Check that the slew worm is secure and correctly in mesh. Clean and re-grease.
- 5) Inspect brakes for operation and wear.
- 6) Grease the knuckle and centre post.
- 7) Inspect the engine fuel tank for damage or leaks.
- 8) Check telescopic boom wear pads and nylon studs (if applicable).
- 9) Check that the end cap on the main knuckle pin is secure and the roll pin is in place.
- 10) Grease the tow hitch assembly.
- 11) Lightly oil the jack pad ball joints and outrigger housings.
- 12) Lightly oil the locating pins on outriggers and axles and the axle clamp bolts.
- 13) Oil and check the operation of manual jacks.
- 14) Check and adjust if necessary the Nylatron studs around the telescope boom.
- 15) Every **three** months check and verify the calibration of the cage weigh system. See section 4.5.4 for the calibration procedure.
- 16) Every **Six** months perform a **thorough examination** in accordance with the 'Lifting Operation and Lifting Equipment Regulations' (LOLER) 1998, Regulation (9)(3)(a).

### **3.3.4 ANNUAL SAFETY CHECKS**

- 1) Check that all pivot pins and their tag bolts are secure.
- 2) Inspect for any cracks or badly rusted areas on booms and chassis.
- 3) Change the hydraulic oil and the oil filters.
- 4) Inspect the suspension on each axle unit.
- 5) Check that slew ringbolts are secure (torque 206ft lbs. 279Nm).



### 3.4 PLACARD, DECALS & INSTALLATION (UK)

ITEM	DESCRIPTION	NUMBER	QTY
1	Daily Safety Checks	P14908	1
2	Tilt alarm	P18842	2
3	General Crush	P14782	10
4	Before Towing	P17341	3
5	Boom Clamp	P19740	1
6	Coupling instructions	P14896	1
7	Harness Point	P14883	2
8	Component Stability	P19708	1
9	Tyre Pressure 65 psi	P14876	2
10	No Step	P14785	7
11	Emergency Hand Pump	P19090	1
12	Cage Gate Warning	P18432	1
13	General Warning	P20330	2
14	Head Protection	P14921	1
15	Serial Plate	P15383	1
17	SWL 200kg	P14801	1
18	Nifty 120T	P14598	2
19	Niftylift.com	P14390	1
20	Push and Release	P19092	1
21	Cage levelling	P10853	1
22	Point Load - 9.4kN	P14962	4
23	Outriggers - Hydraulic	P14841	4
24	Outrigger Controls	P14922	1
25	Hydraulic Controls – 3 lever	P14926	1
26	Hydraulic Controls – 5 lever	P14927	1
27	Base Control	<i>Cage weigh</i> P17219	1
		<i>Non cage weigh</i> P15881	1
28	Warning Stripes		A/R
29	Battery Isolator	P18600	1
30	General Notice	P18863	1
31	Battery Charger	P14904	1
32	Cage Control (E/AC)	<i>Cage weigh</i> P17212	1
		<i>Non cage weigh</i> P15925	1
33	Hydraulic Oil ISO32	P17226	1
34	Petrol Off	P19055	1
35	Diesel ONLY	P14414	1

## **nifty** TM Series

### Operating & Safety Instructions

---

ITEM	DESCRIPTION	NUMBER	QTY	
36	Cage Control	<i>Cage weigh</i>	P17457	1
		<i>Non cage weigh</i>	P15924	1
37	Operating instructions	P14892	1	
39	Overload Warning	P18848	2	
40	Noise Warning 85dB	P17124	1	
41	Traction Drive - Engage	P18890	1	
42	Hand Crush	P14782	2	
43	Blank Axle Plate	P16190	1	
44	If E-Stop disabled...	P14864	2	
45	Tow hitch (Australia/NZ)	P17970	1	
46	Traction Drive – Release	P18975	1	
47	Traction Drive – On slope	P18976	1	
48	Inlet socket	<i>110v</i>	P17719	1
		<i>220v</i>	P17720	1



**Operating & Safety Instructions****3.4a PLACARD, DECALS & INSTALLATION (USA)**

<b>ITEM</b>	<b>DESCRIPTION</b>	<b>NUMBER</b>	<b>QTY</b>
1	Cage Gate Warning	P18432	1
2	Jockey wheel	P14815	1
4	Serial Plate	P15383	1
5	Hydraulic Controls – 5 lever	P14927	1
6	Hydraulic Controls – 3 lever	P14926	1
7	If E-Stop disabled...	P14864	2
8	Tilt alarm	P18842	2
11	Warning Stripes		A/R
13	Rotating Machinery	P15010	2
15	Before Towing	P17341	3
16	Outriggers - Hydraulic	P14841	1
17	Boom Clamp	P19740	1
18	Coupling instructions	P14896	1
19	Max Towing Speed	P17140	1
20	Hand Crush	P14782	1
21	Harness Point	P14883	2
22	Component Stability	P19708	1
23	Tyre Pressure 65 psi	P14876	2
24	General Warning	P20330	2
27	No Step	P14785	7
28	Head Protection	P14921	1
30	Daily Safety Check	P14908	1
31	General Notice	P18863	1
34	SWL 500lbs	P17328	1
35	Outrigger Controls	P14922	1
36	Emergency Hand Pump	P19090	1
41	Cage levelling	P10853	2
42	Point Load – 9.4kN	P14962	4
43	Niftylift.com	P14390	1
44	Nifty TM34T	P14612	2
45	Base Control	P15881	1
46	Battery Isolator	P18600	1
48	Battery Charger	P14904	1
49	Cage Control (E)	P15925	1
51	Petrol Off	P19055	1
52	Cage Control (G/GE)	P15924	1

---

***nifty*™ Series**  
**Operating & Safety Instructions**

<b>ITEM</b>	<b>DESCRIPTION</b>	<b>NUMBER</b>	<b>QTY</b>
53	Operating Instructions	P14892	1
54	Carb Regulations	P15334	1
55	Noise Warning 73dB	P17123	1
56	Footswitch	P14884	1
57	Hand Crush	P14782	2
58	Traction Drive - Engage	P18890	1
59	Traction Drive – Release	P18975	1
60	Traction Drive – On slope	P18976	1



### 3.5 TORQUE REQUIREMENTS

SCREW QUALITY/SIZE		Tightening torque in ft lbs (Nm)			
		8.8		10.9	
Grade					
M 6		7.4	(10)	10	(14)
M 8		18.5	(25)	26	(35)
M 10		36	(49)	51	(69)
M 12		65	(86)	89	(120)
M 14		100	(135)	140	(190)
M 16		155	(210)	218	(295)
M 18		215	(290)	300	(405)
WHEEL NUTS	Standard	80ft lbs		110Nm	
	Traction Drive	110ft lbs		150Nm	
SLEW RING BOLTS		206ft lbs		279Nm	

## **4 Operation**

### **4.1 CONTROL CIRCUIT COMPONENTS**

- 4.1.1 CONTROL BOARD:** - Situated under the canopy, the control box contains all of the wiring and relays to control the machine operation. The control box is common between models with the same power source, and will contain, where appropriate, discrete fuses for the circuits concerned.
- 4.1.2 KLAXON:** - Mounted under the control board box is a klaxon. It is this device that sounds continuously if a jack goes light during operation, (i.e. when the booms are raised) warning the operator of this condition. If the operator attempts to activate the machine by turning the key switch in the platform or the base control unit to the "ON" position and pushing the green button before the jacks are deployed, the klaxon will also sound indicating to the operator that the jacks are not setup correctly.
- 4.1.3 BOOM-SWITCH:** - Mounted on the side of Boom 1 near the boom rest and operated by contact with the boom 3, this switch controls the changeover function between jacks and platform. The jack control function is not available unless this switch is engaged with the boom, ensuring that the machine must be stowed to operate the hydraulic jacks. It is also similarly linked into the platform control circuit, such that if the switch is not engaged with the booms, (i.e. machine is in operation) then the outrigger sensors are active and would warn the operator of an unsafe condition, should one of them loose contact with the ground. These control functions are of primary importance to safety of the machine and operator; under no circumstances should this control function be isolated or by-passed.
- 4.1.4 BATTERY ISOLATOR:** - A grey battery isolator handle is located beneath the canopy which allows the machine control and power circuits to be isolated from the batteries themselves. Under normal operation, the machine Key switch should be used to isolate the machine with the Battery Isolator only being required to disconnect the batteries for maintenance or in the event of a short circuit. The battery charging circuit is connected directly to the battery side, so charging is un-affected by use of this switch.
- 4.1.5 POWER SOURCE SELECTION:** - On multiple power option machines, the machine is fitted with an 'instinctive' circuit for power source selection. Pressing the green button will automatically select battery operation. The engine can be started using the two position START/STOP selector in the platform and the machine will 'default' to engine operation via a flow switch in the hydraulic circuit. Stopping the engine by selecting STOP on the two position selector in the platform and pressing the green button will return the machine to battery mode.
- 4.1.6 DIESEL ENGINE:** - Generally a Yanmar L40 or Kubota 0C60 engine, described in the maintenance section of the Workshop Manual, driving a single bodied pump with direct mounted pump dump valve.
- 4.1.7 PETROL ENGINE:** - Generally a Honda GX 160 engine, described in the maintenance section of the Workshop Manual, driving a single body pump with direct mounted pump dump valve.



## 4.2 SETTING UP PROCEDURES

**FAILURE TO DEPLOY THE OUTRIGGERS CORRECTLY COULD RESULT IN DEATH OR SERIOUS INJURY.**



### ALL MODELS

- 1) Read and fully comply with all safety precautions and operating instructions in the Operating and Safety manual and the warning decals on the machine.
- 2) Position Niftylift on firm ground, bearing in mind range of boom movement so that any overhead obstructions or possible hazards such as, but not limited to, power cables, telephone lines, drains, manhole covers, etc. can be safely avoided
- 3) **APPLY HANDBRAKE:** Chock wheels and cordon off the area using appropriate cones, barriers and flags.
- 4) Levelling the machine using the hydraulic outriggers can accommodate a slope of up to 12 degrees, if necessary using suitable load bearing pads to support the downhill jacks. Do not elevate the platform unless the base can be corrected to within three degrees of level.
- 5) If the load bearing capacity of the ground is in any doubt the machine must **NOT** be used.
- 6) Release boom travelling clamp.
- 7) Check all red emergency stops are not engaged (i.e. fully out).
- 8) Ensure that the key switch at the ground control station is turned to the “ON” position (i.e. clockwise).
- 9) At the outrigger control station press down and hold the power lever on the right hand side. This activates the power and diverts hydraulic flow to the legs for setting up. Then select the appropriate control lever to begin setup. Note: No power will be available if the booms are not stowed onto the boom rest.
- 10) Using the four outrigger control levers, lower each outrigger onto a firm, level surface and level the machine base ensuring each outrigger foot is taking equal weight with the wheels clear of the ground. Note: Deploy the front two outriggers first to minimise the risk of damaging the jockey wheel.
- 11) Check that the base is level using the spirit level adjacent to outrigger control station as a guide.
- 12) The booms can now be operated from the ground control station by pressing and holding the green power button. Note: If the klaxon alarm sounds check that each outrigger is lowered and each footpad is taking equal weight.
- 13) Always lower booms fully before adjusting, raising, retracting or moving the outriggers in any way.
- 14) Never alter, modify or block any of the safety circuits on the Niftylift.

**THIS MACHINE IS NOT ELECTRICALLY INSULATED. DO NOT WORK WITHIN 10FT (3M) OF OVERHEAD CABLES EXCEEDING 415 VOLTS**



---

**Operating & Safety Instructions**

**4.3 GROUND CONTROL OPERATION**

**ALWAYS ALLOW THE ENGINE TO WARM UP BEFORE OPERATING.**



**4.3.1 GROUND CONTROL INSTRUCTIONS**

**ALL MODELS**

- 1) Check below, above and around the platform for any obstructions or hazards before operating any function.
- 2) Ensure all red emergency stops are out.
- 3) Turn the key switch at the ground control station to the “ON” position (i.e. clockwise).
- 4) Battery/Electric models go to step 11).

**DIESEL ENGINE OR BI-ENERGY MODELS**

- 5) Turn the main engine ignition switch, located on the side of the canopy through “ON”, to the “ST” (start) position and the engine will fire.
- 6) Go to step 11). Note – Unless the diesel engine is running, the 120T will automatically default to the primary power source (usually battery)

**PETROL (GASOLINE) ENGINE OR PETROL (GASOLINE)/ELECTRIC MODELS**

- 7) For a cold engine start go to step 8) or for a warm engine start go to step 9).
- 8) **COLD ENGINE:** - turn the engine fuel tap “ON” and engage the choke lever. Turn the main engine ignition through “ON” to “ST” (Start) and the engine will fire. Return the choke lever to its normal running position after the engine is started.
- 9) **WARM ENGINE:** - turn the engine fuel tap on and turn the main engine ignition through “ON” to “ST” (start) position and the engine will fire.
- 10) Go to step 11). Note – Unless the petrol engine is running, the 120T will automatically default to the primary power source (usually battery)

**ALL MODELS**

- 11) Push and hold green power button.
- 12) Select the boom function required and operate hand levers in full accordance with manufacturers Operating and Safety manual.
- 13) When not in use return machine to stowed position, fully raise and stow all outriggers, turn the key to the “OFF” position (i.e. anti-clockwise), remove key and chock wheels.

**EMERGENCY PROCEDURES**

- 1) Push in red emergency stop to shut down all functions.
- 2) Use emergency hand pump to provide motive power and manoeuvre the machine as normal using the hand levers (Platform or Base).

### 4.3.2 BOOM FUNCTIONS

- 1) Push and hold green power button.

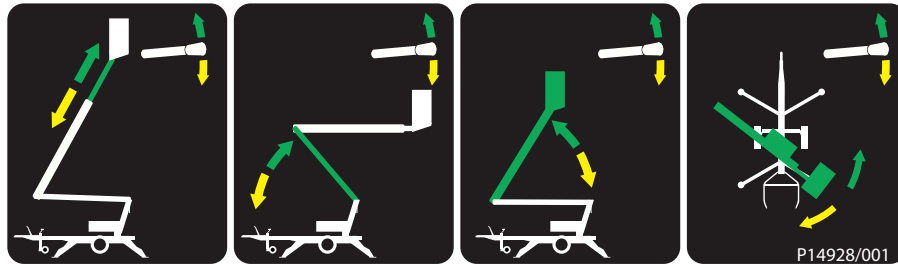

- 2) Select lever 1, 2, 3 or 4 for desired boom function.

<b>1</b> Operates Telescope	<b>UP</b> for out	<b>DOWN</b> for in. **
<b>2</b> Operates Lower Boom	<b>UP</b> for up	<b>DOWN</b> for down
<b>3</b> Operates Upper Boom	<b>UP</b> for up	<b>DOWN</b> for down
<b>4</b> Operates Swing	<b>UP</b> for right	<b>DOWN</b> for left

\*\* (If applicable, Ground control of telescoping is optional).



**ALWAYS ENSURE THE AERIAL PLATFORM IS ON A FIRM SURFACE AND THE AREA IS FREE OF ANY OVERHEAD OBSTRUCTIONS.**

**ENGAGING THE RED EMERGENCY STOP BUTTON WILL SHUT DOWN THE ENGINE AND THE ELECTRIC CIRCUIT PREVENTING OPERATION OF ANY FUNCTION.**

---

## Operating & Safety Instructions

### 4.4 PLATFORM CONTROL OPERATION



**NEVER START THE NIFTYLIFT IF YOU SMELL PETROL (GASOLINE), LIQUID PROPANE OR DIESEL. THESE FUELS ARE FLAMMABLE.**

**BEFORE OPERATING THE NIFTYLIFT ENSURE THAT EACH OPERATOR HAS READ AND FULLY UNDERSTOOD THE OPERATING MANUAL. FAILURE TO DO SO MAY RESULT IN DEATH OR SERIOUS INJURY.**

**\*\*\*FOR COLD START PROCEDURES SEE SECTION 4.3.1\*\*\***

**ALWAYS ALLOW THE ENGINE TO WARM UP BEFORE OPERATING.**

#### 4.4.1 PLATFORM CONTROL INSTRUCTIONS

##### ALL MODELS

- 1) **NEVER** exceed the maximum platform capacity.
- 2) Check below, above and around the platform for any obstruction or hazards before operating any function.
- 3) Ensure all red emergency stops are out.
- 4) Remove the key from the ground control station (turn key anti-clockwise) and put the key in the platform control station and switch to "ON" (clockwise).
- 5) Battery electric models go to step 11).

##### DIESEL ENGINE OR BI-ENERGY MODELS ONLY

- 6) Ensure that the main engine ignition switch is "ON". Turn the "Engine Start" switch on the platform control box clockwise and the engine will fire.
- 7) Go to step 11). Note – Unless the diesel engine is running, the 120T will automatically default to the primary power source (usually battery).

##### PETROL ENGINE OR PETROL/ELECTRIC MODELS ONLY

- 8) Ensure that the fuel tap is turned to the "ON" position and that the main engine ignition switch is "ON". Turn the "Engine Start" switch on the platform control box clockwise and the engine will fire.
- 9) Go to step 11). Note – Unless the petrol engine is running, the 120T will automatically default to the primary power source (usually battery)
- 10) If the engine is too cold to start from the platform, try starting from the ground controls as described in step 8) of the ground control operation section (4.3.1).

##### ALL MODELS

- 11) Push and hold green power button.
- 12) Select the boom function required and operate hand levers in full accordance with manufacturers Operating and Safety manual.
- 13) When not in use return machine to stowed position, fully raise and stow all outriggers, turn the key to the "OFF" position (anti-clockwise), remove key and chock wheels.

**EMERGENCY PROCEDURES**

- 1) Push in red emergency stop to shut down all functions.
- 2) Use emergency hand pump to provide motive power and manoeuvre the machine as normal using the hand levers (Platform or Base).

**PLATFORM CONTROL STATION**

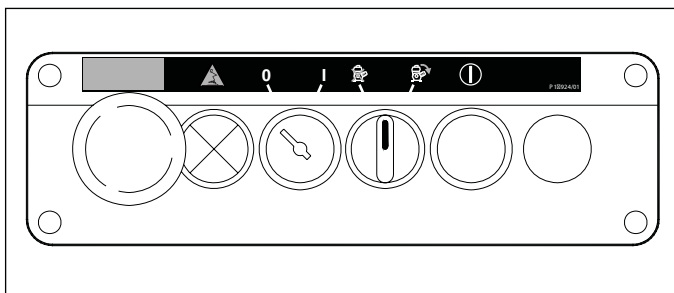

**(BI-ENERGY MODEL)**

**4.4.2 BOOM FUNCTIONS**

- 1) Push and hold green "Power Control" button

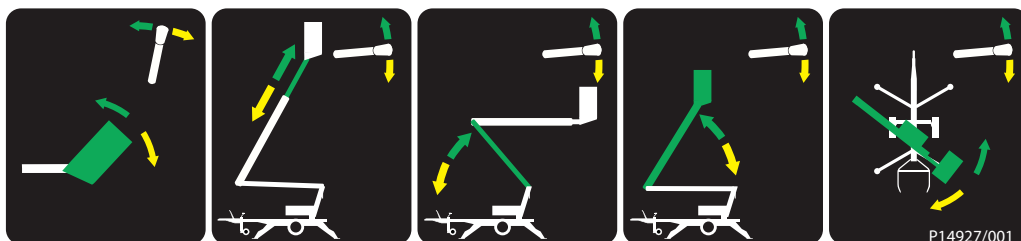

- 1                      2                      3                      4                      5

- 2) Select lever 1, 2, 3, 4 or 5 for desired function

<b>1</b> Operates Platform Lev.	<b>FWD</b> for forward	<b>BACK</b> for back
<b>2</b> Operates Telescope	<b>UP</b> for out	<b>DOWN</b> for in.
<b>3</b> Operates Lower Boom	<b>UP</b> for up	<b>DOWN</b> for down
<b>4</b> Operates Upper Boom	<b>UP</b> for up	<b>DOWN</b> for down
<b>5</b> Operates Swing	<b>UP</b> for right	<b>DOWN</b> for left

## **Operating & Safety Instructions**

### **4.5 CAGE WEIGH SYSTEM**

#### **4.5.1 MECHANICAL VERSION**

The Niftylift range of machines is available fitted with mechanical cage weigh systems. These are configured to sense a vertical cage overload, which when detected will halt the machine movement. No further use of the platform is then permitted until the overload has been removed. This must be done in a responsible manner and not one in which a greater hazard might be induced. Therefore, if the addition of external items such as light fittings; brickwork or tiles etc were allowed into the cage, the machine would not operate. In order to restore the functions, the excess load should be safely removed, NOT by discharging them out of the basket to the detriment of persons below.

The mechanical cage weigh system works on the principle of a pre-loaded spring, rated to the cage safe working load. Excess load in the cage forces the spring to further compress, the movement of which is detected by a precision micro-switch. With the machine turned 'On', this movement first gives an audible alarm in the cage, as well as a visual indication at both control positions (cage and base). Additional deflection due to increased load serves to cut off the machine control circuit, effectively halting all machine movements.

Under the circumstances where the cage overload cannot be removed, the machine can only be manoeuvred by use of the emergency hand pump. Great care must be taken when utilising this facility, especially if the machine is significantly overloaded; any motion that causes the machine outreach to increase could induce instability. The machine must be manoeuvred in such a manner as to reduce outreach, then height, until a safe level is reached to permit the operator to dis-mount or the overload to be removed.

#### **4.5.2 FUNCTION**

The cage overload system is powered from the machine control circuit, so the system is inactive if the machine is turned 'Off'.

'Enabling' the emergency stops allows the system to become 'active', when either the cage or base key switch is turned 'On'. If the cage is overloaded, the control circuit will immediately indicate this by the audible and visual alarm. Pressing the emergency stop or turning the key switch to the 'Off' position merely silences the alarm. The alarm will continue to sound as long as the overload persists, unless the machine is turned 'Off'.

Whilst the overload is detected, pressing the green button at base or cage will generate no response from the control circuit. The machine will not function under power until the overload is removed. Removing the overload as previously described will re-set the system automatically, requiring no additional intervention from the operator. All machine functions will be restored.

#### **4.5.3 TESTING**

At the simplest level, before working on the platform, the function of the cage overload can be checked by the following method: - Place two men into the cage and a larger quantity of tools than is permitted to be carried. (Typically 40 kg). The alarm should sound and all functions should be lost. Reducing the cage contents to the safe working load should silence the alarm and restore the machine operation.

#### **4.5.4 CALIBRATION**

If a closer examination of the system is required, typically for testing and approval, the safe working load should be placed in the cage, carefully weighing the test load to ensure accuracy. The addition of a 5kg weight, to any of the four corners of the cage, should sound the alarm. If the alarm does not sound, carefully inspect the weigh mechanism for signs of damage. All parts of the weigh mechanism should be free to move, and the inspection should look for any impact damage that might have caused the assembly to become disabled, for any reason. If the mechanism seems to be functioning correctly, the adjustment of the weigh sensing micro-switch should be checked. A competent person, who has the authority to perform such adjustments, must perform this. Adjustment must not be permitted by anyone without the approval of the person responsible for the platform.

With the machine emergency stops 'enabled' and either the cage or base key switches turned 'On', the cage weigh micro switch is adjusted to bring the bolt into contact with the micro-switch roller. Continue adjustment until the alarm sounds, then back off slightly to silence the alarm. The locknuts supporting the adjustment bolt can be partially tightened to lock the bolt in place.

The addition of a 5 kg weight should now be used to prove that the system detects the applied overload, sounds the alarm and disables the machine. The sensitivity of the assembly is such that the alarm will sound slightly before the functions are disabled. The mechanism should be adjusted to allow the alarm to sound and functions to be lost within this 5 kg limit. Lock the adjustment screw securely.

The over-travel adjusters can now be used to protect the micro-switch from excess forces should a substantial overload be applied to the cage. (Typically if the machine is manoeuvred into contact with a fixed object, snagging the cage assembly, this would be detected as an overload to the system.) Adjust the screws forward until they come into contact with the cage weigh mechanism, then with the cage overload still applied and the alarm sounding, functions disabled and machine not operating, lock them in this position. Care should be taken to not turn the adjuster screws in too far; otherwise the overload signal might be lost.

The machine can then have the overload removed and the functions of the machine checked for correct operation.

#### **4.5.5 INSPECTION**

The cage weigh system is controlled through the detection printed circuit board, part number P16164. This PCB is connected directly to the safety micro-switch and monitors the function of the cage weigh system. The two relays are configured such that both need to operate to permit safe operation of the assembly. Should either of them fail, an error signal is generated which can be seen on the printed circuit board itself. This occurs if pressing the green button does not allow the machine to operate, no overload signal to be given, with no load in the cage. In this case, open the cage pushbutton box or separate box containing the PCB and look at the printed circuit board.

There are three LED's (Light Emitting Diodes) on the board, Red LD1 for 'Overload', Red LD2 for 'Relay 1/2 failed' and Green LD3 for 'Machine enable'. The first indicates the overload when the machine is turned 'On', the second indicates a relay failure when the green button is pressed, and the third shows the machine is enabled, again when the green button is pressed.

## **Operating & Safety Instructions**

The failure signal is generated if either relay fails to respond to the 'safe' cage weigh signal from the safety micro-switch, either due to a coil or contacts failing or if a contact sticks in place due to welding. Under either circumstance the 'enable' signal is blocked, instead generating the error message, illuminating the red LD2. The machine will not operate under this situation. The red error signal from LD2 requires the board to be changed, as the relays are not serviceable items.

### **4.5.6 MAINTENANCE**

The cage weigh mechanism is supported on maintenance-free precision needle roller bearings for smooth running and friction-free operation. The accuracy of the entire assembly and in particular the hysteresis is dependent on these components. Keeping them free of dust and dirt is recommended; and an occasional application of WD40 to the external faces should keep them mobile and deny the entry of dust and moisture.

The hysteresis is the amount of load required to be removed before the system re-sets allowing continued operation.

If the assembly is subjected to any external impact force, typically whilst manoeuvring the machine under power, or in the case of trailer units, whilst being reversed into position, the cage assembly will require close inspection. If there is evidence of any deformation in any part of the structure, then the advice of a Niftylift Service technician should be sought. Physical damage to the assembly is liable to render the cage weigh system inactive, or to affect the accuracy of the result. Under no circumstance permit a damaged machine to enter service without performing a thorough inspection and calibration of the weigh assembly.

For this reason it is not recommended to restrain the machine in transit using strap or chains passed through or over the cage itself. This is particularly true of the electronic load cell system, which could be permanently damaged by the application of such excessive external forces. Whilst the mechanical system could be considered to be more robust in operation, the same restraint forces that could be generated through ratchet straps and the like, is likely to cause some severe deformation in the lightweight cage structure. Use only the designated tie-down points on your Niftylift when strapping the machine down for transport. Failure to observe this instruction could render the machine unusable, and a considerable repair bill for the damaged components.

### **4.5.7 REPLACEMENT**

If components are replaced, they must be genuine Niftylift parts. The accuracy and function of the cage weigh system relies on the like-for-like application of the component parts. A switch from a similar manufacturer might reverse the contact arrangement and critically affect the function of the mechanism. Similarly, the accuracy of the sensing circuit relies on the duplication of the contact travel within the switch itself. Using a non-equivalent component will render the cage weigh system inactive. Under no circumstances should you permit a machine with a defective cage weigh assembly to enter service.

If in doubt about the operation or function of your machine, always request the circuit diagram that goes with the machine serial number. Look at the bottom of the machine serial plate; one of the final two numbers stamped there will give the electrical circuit for the machine. ('D80000' number, plus the issue status immediately afterwards: - /01;/02;/03; etc, see Section 1.5 & 1.5a, pages 5/6)

If in doubt, contact the Niftylift Service Department on (44) 01908 223456, Fax: 01908 227460.



## 4.6 BATTERIES AND CHARGING



**BATTERIES MUST BE RECHARGED IN A WELL-VENTILATED AREA FREE OF FLAME, SPARKS OR OTHER HAZARDS THAT MAY CAUSE EXPLOSION. HIGHLY EXPLOSIVE HYDROGEN GAS IS PRODUCED DURING THE CHARGING PROCESS.**

- 1) Recharge batteries at the end of every working day or shift.  
(**Note:** To recharge batteries fully from flat takes approx. 12 Hours, this consists of 8 hours bulk charging plus 4 hours equalisation).
- 2) Plug charger into suitable power supply, either 240 volts or 110 volts AC (see **Charging Limitations**). (Note: If using 240V, use of a suitably rated Earth Leakage Circuit Breaker (ELCB) or Residual Current Device (RCD) at the point of supply is highly recommended).
- 3) Take note of the indicators provided:  
**Red Light** - Batteries are charging.  
**Pulsing Green light** - the charge is equalising.  
**Constant Green light and pulsing Red light** - the batteries are fully charged.



**UNDER NO CIRCUMSTANCES SHOULD BATTERIES BE LEFT ON CHARGE FOR PERIODS IN EXCESS OF 24 HOURS**

- 4) **DISCONNECT FROM POWER SUPPLY ONCE BATTERIES ARE FULLY CHARGED.** The machine can now be left unattended, however, in the event of the machine being left unused for extensive periods then a **4 to 6 hour** 'top-up' charge every **4 weeks** is recommended. A 'top-up' charge the day before use ensures a full day of operation from the machine.



**UNDER NO CIRCUMSTANCES SHOULD A MACHINE BE LEFT FULLY DISCHARGED AS SEVERE BATTERY DAMAGE CAN OCCUR IN A RELATIVELY SHORT TIME.**

- 5) To avoid damage to charger disconnect from mains supply before using machine.

**Note:**

- 1) If the charger is reconnected to the power supply shortly after it has gone through its full charging cycle the Red LED may come on although the batteries may be fully charged. The charger would then go through its complete cycle again at an accelerated rate, depending on the time difference between connection, reconnection and level of battery charge.

## Operating & Safety Instructions

---

- 2) Some Niftylifts are fitted with a Battery Management System, which permanently monitors the condition of the batteries. When the batteries become discharged to 20% of their capacity the management system will begin to "shut down" the hydraulic power packs. This causes the drive/boom operating system to alternately stop and start, signalling to the operator that re-charging is necessary. However, there is sufficient power remaining to enable the operator to drive slowly to the nearest charging point.

Should the operator ignore the onset of the battery discharge warning the "shut down" of the motors will continue, until the machine is rendered in-operative. **Immediate charging will then be required.**

### CHARGING LIMITATIONS

Battery charging times will increase slightly if using an 110V supply as opposed to a 240V supply. This is due to the connection of the primary coils being in parallel, which in effect only allows the transformer to see 220V. Similarly, the capacity of the 110V supply will decide the input current available; hence a small hand-tool transformer will not operate the battery charger efficiently, therefore:  
- charging times will increase further due to input limitations.

Attention should also be given to the use of extension cables as power leads. Excessive cable lengths from the supply point to the battery charger will result in significant voltage drop, leading to a reduction in the chargers efficiency. In addition, inadequate sized cable cores will have a limiting effect on its current carrying capacity, which will again lead to a reduction in the chargers efficiency. Both of these can result in over-heating of the cable with the attendant risk of fire, short circuits or damage to the components themselves.

The charger requires a minimum battery voltage of 4.5 volts per battery (overall for two batteries 9 volts, for 4 batteries 19 volts for 8 batteries 38 volts). If the voltage is below these values then the charger will not function (Charger will not detect batteries to begin charge.) If the batteries have fallen to such a poor state they will have to be removed from the machine and charged individually with an independent charger until the optimum voltage has been reached. This is best performed at very low currents to 'recover' the batteries if sulphation has already started i.e. a 'trickle' charger. This can take several hours, possibly days. Careful monitoring of the rise of battery voltage will indicate when recovery has been achieved.

### TOPPING UP

During the course of normal operation, the batteries should be inspected at least once a fortnight to check the level of electrolyte. During the end of charge, gassing takes place, which will cause a slight reduction in the volume of acid in the battery. This can be topped up with de-ionised water as required. During this inspection, it is useful to note any imbalance in the fluid levels. One indication of a faulty cell would be an increase in the loss of battery acid, which would then require more frequent topping up on that cell, or cells. Faulty cells can liberate excess hydrogen, even during normal operation, with the resulting risk of explosion if ignited. **Any faulty batteries should be replaced as soon as possible with an equivalent sized and rated unit.**

**Note: BATTERIES CONTAIN ACID, therefore: - protective safety glasses and gloves (Appropriate PPE) MUST be worn whilst performing these checks.**

## **4.7 TRANSPORTING, TOWING, CRANEAGE, STORAGE AND SETTING TO WORK**

### **4.7.1 TRANSPORTING**

If a work platform is to be moved over a longer distance, whether the machine is trailer mounted, vehicle mounted, self propelled or tracked, the following procedure should be read before restraints are attached to the machine. Cross loading is most frequently the cause of problems, as the method of loading is no longer in sight of our own personnel. The recommendations made herein should be passed on to subsequent carriers, such that the entire journey is carried out without incident.

- Always ensure the truck or trailer you are loading or towing the Niftylift with can carry it legally.
- If loading by crane the use of shackles and an adequately rated spreader beam, with four leg slings, is **MANDATORY**.
- When loading or un-loading from the side of the vehicle, the use of the forklift pockets to retain one of the forks is recommended. (If fitted). Spread the forks to their widest capacity, with due regard to the components fitted to the machine. Never forklift or crane an entire machine under the booms, always lift beneath the spine or under the ends of the axle mountings in the case of a self-propelled unit. Ensure forklift is adequately rated for the load to be carried.
- Once positioned on the transport carrier ratchet straps should be used to secure the machine. The machine should be positioned to allow easy access around the machine in transit, and to ensure that 'creepage' during transport does not permit the machine to come into contact with other goods being shipped, or the container itself. Some movement of the machine structure might occur during transit, which could lead to fretting or other damage.
- If the machine is equipped with a transit device such as a boom clamp etc, this should be securely applied.
- Strap booms carefully to constrain them from sideways movement. When using straps or chains, adequate packing should be applied to stop any damage to the structure and paintwork. Due regard of the movement of the straps or chains must be taken into account.
- Where a machine has designated points for strapping, lifting or forking, these can be used for tie-down duty. When they are absent, the major structure of the platform can be used, giving due consideration to the design and function of the area chosen. Where possible, use the spine of the machine or axle mounts over which to apply the holding down forces. Using a single plate, such as an outrigger or stabiliser support plate might be unsuitable. If the component was clearly not designed to accommodate a side load, one should not be applied.
- Under no circumstances should straps or chains be applied over booms or through the cage support structure or the cage itself. The relative strength of the carrying structure is not conducive to the massive forces capable of being applied through ratchet chains or slings. Severe damage to the steelwork can be caused, as well as deformation to sensitive mechanisms such as cage weigh assemblies, which would render them useless. Such catastrophic damage to say, an electronic load cell would require the component to be replaced before the machine would function.

## Operating & Safety Instructions

---

### 4.7.2 TOWING



**THE MAXIMUM RECOMMENDED TOWING SPEED OF A NIFTYLIFT IS 45 MPH (72 KMPH) WITH A VEHICLE THAT COMPLIES WITH ALL ROAD TRAFFIC REGULATIONS. SPEEDING MAY RESULT IN DEATH OR SERIOUS INJURY.**

It is recommended that the maximum towing speed of 45mph (72kmph) be adhered to for the greatest safety. In other than perfect conditions it is sensible to further reduce your speed in order to ensure full control over your vehicle and trailer. The importance of the suitability of your towing vehicle must be stressed. The manufacturers' details concerning each model will give you recommended Gross Vehicle Weights (GVW) or Gross Train Weights (GTW) neither of which should be exceeded.

**POSITION TOWING VEHICLE AND TRAILER ON LEVEL GROUND BEFORE ATTEMPTING TO COUPLE/DE-COUPLE.**

#### **Coupling Instructions**

- 1) Depress the trigger on the lever mechanism and lift the handle upwards and forward.
- 2) Place the unlocked coupling head onto the towing ball and apply slight downward pressure. The head will automatically lock onto the ball.
- 3) Ensure that the trigger has returned to its free position before attempting to tow, and that the coupling head is securely on the towing ball.
- 4) Connect the breakaway cable/chain to the towing vehicle hitch - not to the tow ball itself.
- 5) Connect the lighting plug to the vehicle and check the light functions.
- 6) Raise the jockey wheel to its stowed position and secure for transit.

#### **De-coupling Instructions**

- 1) Apply trailer handbrake and chock wheels.
- 2) Lower the jockey wheel to the ground. Disconnect the breakaway cable/chain and lighting plug.
- 3) Operate the handle by depressing the trigger and manually lift the coupling head clear of the towing ball or screw down the telescopic jockey wheel to achieve the same effect.

#### **Handbrake Operation**

- 1) To operate the trailer parking brakes pull the handbrake lever upwards and backwards. The spring loaded mechanism will engage and stay in the operated position until re-set.
- 2) To disengage the parking brakes, firmly grasp the handbrake lever and pull upwards. Depress the ratchet release button in the end of the handbrake lever and return the lever to the horizontal position. Care should be taken when operating the handbrake lever due to the forces involved in engaging the ratchet mechanism.

**4.7.3 CRANEAGE**

- 1) Observe all of the limitations relating to straps and chains stated above under 'Transporting'. (Section 4.7.1)
- 2) When utilising the designated lifting points never apply a 'snatch' load, i.e. lift slowly to take up the load before raising. Similarly, do not drop machine when positioning after lifting.
- 3) If the machine is to be lifted by crane, use the designated lifting points and observe the recommendations regarding spreader beams. Individual drawings are available for each machine type, on request. (See list below.)

D80904	90
D81193	120M
<b>D80541</b>	<b>120T/H</b>
D80905	140H
D81273	150T
D80906	170H
D80939	210

**4.7.4 STORAGE**

If being stored for any length of time without use, then the machine should be thoroughly inspected for the following: -

- 1) Grease all bearings /slides, worm drives, etc.
- 2) Check batteries for electrolyte levels, state of charge, damage, dirt, etc. Never leave in a state of discharge for any length of time. If no use of the platform is intended, an occasional "top-up" charge of the batteries will serve to equalise their charge level.
- 3) Leave battery disconnect switch in OFF position to prevent discharge of batteries through leakage.
- 4) If machine is to be left on an incline, chock wheels to prevent creep.
- 5) If machine is to be left out-of-doors or in a hostile environment, cover with suitable weatherproof media to prevent deterioration.

**4.7.5 SETTING TO WORK**

Before use each day and at the beginning of each shift the machine shall be given a visual and functional test including, but not limited to, the following

- 1) Check all lubrication points for adequate application of grease, oil etc.
- 2) Inspect all threads for ease of operation.
- 3) Check level and quantity of oil. Remove any contaminants - water, etc.

### **Operating & Safety Instructions**

- 4) Check batteries for electrolyte and state of charge.
- 5) Check electrics for damage and insulation.
- 6) Using base controls, cycle machine over complete envelope in accordance with the Operating Instructions. Cure any defects.
- 7) Ensure that all safety devices and controls operate in accordance with the instructions.
- 8) If necessary, perform a load test to establish the machine stability before putting the machine to work.
- 9) On completion of an extended period of road transport, the machine might need additional inspection to identify any transit degradation, which could render the machine unsafe. Perform a P.D.I. inspection on the unit before it enters service. Record any faults found and rectify them immediately.
- 10) If left un-attended for an extended period, it is likely that the hydraulic cage levelling will become un-pressurised. Normal operation is then lost, with a noticeable delay in the forwards or backwards motion as the booms move. To restore normal function, the cage needs to be fully levelled forwards and backwards, using the cage-levelling lever whilst not standing in the cage (i.e. with the operator standing adjacent to the cage side whilst simultaneously operating the lever and green button to move the cage). Take care not to become trapped between the moving cage and a fixed object, and ensure those around you are clear of the moving cage. When the system has been charged in both directions, the cage levelling function should be restored. If the system operates but is 'jerky' in either direction, this indicates air in the system. Repeat the procedure as described above until the movements are smooth and un-interrupted. If in doubt, contact our Service Department for further advice.

Niftylift Limited is not liable for any third party damage caused during transport. Careful attention to correct procedures will prevent many of the small snags that can happen in transit. Re-work is both expensive and time consuming. A defective machine arriving at the place of work is a poor advertisement for our product, the company's reputation and those of our dealers and clients. The responsibility for safe and damage-free transport rests with the haulier or his representatives.

## **4.8 TRACTION DRIVE**

On those trailer machines equipped primarily with fixed width axles, a traction drive system is an available option. This function allows the machine to be manoeuvred by one man, and provides the machine with the capability of ascending or descending a slope of 10% (5.7 degrees). Slopes in excess of this angle should not be attempted and a towing vehicle used instead.

The traction system is hydraulically driven, the supply being taken from the same power source as the base machine. The drive speeds and gradeability are therefore linked into the available power from the vehicle prime mover. The engagement of the traction system is also hydraulic, using a single hand lever to bring the drive cradles into contact with the road wheels. The control of the traction function is then possible from a single joystick permitting the machine to be moved forwards, backwards and steered on either side.

### **4.8.1 ENGAGING DRIVE**

- 1) Before engaging the traction drive system, ensure that the machine is de-coupled from the towing vehicle, the jockey wheel deployed and securely fixed, and the parking handbrake is fully engaged.
- 2) Check that all of the emergency stops are released, i.e. 'Out', and that the Base Key switch is in the 'On' position, thereby directing the electrical feed to the drive joystick and jack station.
- 3) The Drive joystick has a single pushbutton located on the handle. Pushing and holding this button allows the power unit to produce hydraulic flow, which is directed to the drive manifold. It is not necessary to operate the jack selector lever, as this would deviate the hydraulic flow to the jack manifold and render the drive inoperative.
- 4) Whilst holding the joystick button and keeping the drive lever in the upright position, it is possible to use the third horizontal control lever to engage the traction drive. By pulling the lever upwards, the engagement cylinder will rotate the twin drive motors until the cradles come into contact with the road wheels. This function is pressure protected, and the lever should be held to allow the cradles to 'push' into the pneumatic tyres for best grip when driving. This pressure is set to 80 bar in the factory, and should not need adjustment.
- 5) When the engagement cylinder achieves full travel and the cradles are in adequate contact with the road wheels, the lever and drive button can be released, locking the engagement cylinder in this position. Only then should the parking handbrake be released, holding the machine on the traction drive assembly.
- 6) The machine can now be manoeuvred using the drive joystick, holding the button whilst moving the joystick in the direction of travel. It should be noted that the machine drives in the direction the handle is moved, such that if the joystick is released, the machine will not drive towards the direction the lever was being pulled. This decreases the risk of entrapment of the operator. To halt the drive function, release either the joystick, which will return to the centralised 'Off' position, or release the button to stop the hydraulic flow. The Emergency Stops can be similarly used to halt the machine drive at any time.

---

## Operating & Safety Instructions

### 4.8.2 DISENGAGING DRIVE

- 1) Unless the machine has been manoeuvred to allow it to be coupled to a towing vehicle (as described in the appropriate section of this handbook), before disengaging the traction drive system the parking handbrake must be fully engaged. On no account disengage the traction drive system unless the handbrake is engaged, the wheels are securely chocked or the machine is connected to a towing vehicle. It is also recommended that the machine be positioned on flat, level ground before the drive system is disengaged.
- 2) Push and hold the drive joystick button to develop hydraulic flow, and using the third horizontal lever push downwards to retract the engagement cylinder. The traction drive cradles will swing clear of the road wheels, which should be allowed to travel outwards to their fullest extent. Releasing the third lever will then lock them in the retracted position, ready for towing.

**On no account should the machine be towed with the traction drive system still engaged – serious damage may result.**

**Do NOT use the traction drive as a brake – the parking handbrake must be utilised for this purpose.**

**Never disengage the traction drive unless the handbrake is engaged, OR the wheels chocked, OR the machine directly and securely connected to a suitable towing vehicle.**

**Always position the machine on flat, level ground before disengaging the traction drive system.**

**Do NOT engage or disengage the traction system whilst on the move. Stop the machine first and engage the handbrake.**

**It is recommended that any slopes be approached in the direction that allows the tow hitch to be lower than the rest of the machine, ensuring that the jockey wheel keeps adequate weight throughout. Descending a slope with the tow hitch highest might allow the machine to tip backwards, particularly if a sudden stop is made. To maximize the residual load on the jockey wheel, allow the tow hitch to run as low as possible to the ground whilst supporting the nose weight on the retracted jockey wheel.**

**Do not ride on the machine whilst using the traction drive, nor stand inside the machine structure as serious injury may occur.**



## 5 Emergency Controls

### 5.1 GENERAL

**CHECKING THE OPERATION OF THE EMERGENCY CONTROLS EVERY DAY AND/OR BEFORE EACH SHIFT IS AN ESSENTIAL PART OF THE OPERATOR'S DUTIES**



The operator and all ground personnel must be thoroughly familiar with the location and operation of the EMERGENCY CONTROLS.

### 5.2 IN THE EVENT OF AN INCAPACITATED OPERATOR

Turn the key switch selector at ground control station to ground (i.e. fully down). Lower on ground controls as detailed under section 4.3 Ground Control Operation.

### 5.3 IN THE EVENT OF MACHINE FAILURE

Operate manual hand pump (located adjacent to the base controls) and lower platform to the ground using either platform or base controls. If initial movement of the machine allows the master alarm to reset, normal controls will be available. This is then the fastest method of lowering the platform to the ground.

**Note** If the machine is fitted with a cage overload system, and the cage comes into contact with a fixed object whilst operating at height, this would be detected as an overload condition. All power to the machine controls would be lost, requiring the machine to be recovered using the **Emergency Hand Pump**. It is sufficient for the cage to be manoeuvred away from the collision point to release the cage weigh system, thereby restoring normal machine operation. The cage could then be brought down using the controls as described previously.

### 5.4 INCIDENT NOTIFICATION

It is a mandatory requirement that any accident or incident involving a Niftylift, regardless of whether any party received injury or property was damaged, be reported by telephone directly to Niftylift. Failure to do so may render any warranty on the machine void.

## **6 Responsibilities**

### **6.1 CHANGES IN OWNERSHIP**

When a change of ownership of a Niftylift occurs, it shall be the responsibility of the seller to notify Niftylift direct of the unit, model and serial number and the name and address of the new owner within 60 days. This important step is required so that all future Technical Bulletins are able to reach the registered owner of each machine without delay. Please note warranties are not transferable.

### **6.2 MANUAL OF RESPONSIBILITIES**

You are required by ANSI/SIA 92.2 1990, to read and understand your responsibilities before you use or operate this aerial platform.

Please read the enclosed document, as failure to do so could result in death or serious injury.

Wherever any contradiction may appear, the Manual of Responsibilities shall take precedence over all other documents.

**6.3 Inspection/Service/Pre-Hire Check list**

**MACHINE SERIAL NO** \_\_\_\_\_

<b>TOWING</b>	<b>PASS</b>	<b>FAIL</b>	<b>N/A</b>
Operation of tow coupling			
Operation of handbrake			
Operation of jockey wheel			
<b>STABILISERS</b>			
Micro-switches secure			
Locating pins operating freely and oiled			
Stabilisers operate smoothly			
Operation of each micro-switch and klaxon (if fitted)			
Operation of jack control valve and buttons			
Operation of each hydraulic jack			
Operation of each micro-switch including siren			
Operation of boom rest micro-switch			
<b>AXLES, WHEELS AND BRAKES</b>			
Axles slide freely (90/120), or are secure (170/180)			
Wheels are secure, tyre condition acceptable			
Wheel bearings OK			
Mudguards are secure			
Locating pins operate freely and oiled			
Lock bolts are tight			
Wheels spin freely when handbrake is released			
Brakes come on equally when handbrake is applied			
Brake linkages and cables secure			
Brake shoe wear not excessive			
Breakaway cable fitted and operable			
Lighting board fitted, lights function			
Tyre pressure correct			
Wheel nut torque correct			
<b>BASE</b>			
Operation of base control valve and buttons			
Operation of all booms over full range			
Cylinders are silent			
Platform is level over full range			
Booms, levelling rods not damaged or distorted			
Booms, levelling rods, cylinders not fouling			
Hoses not tight, kinked or fouled			
Operation of emergency hand pump			

# nifty™ TM Series

## Operating & Safety Instructions

<b>SLEWING</b>	<b>PASS</b>	<b>FAIL</b>	<b>N/A</b>
Slew assembly and motor are secure			
Worm/wheel mesh correct, no excessive wear			
No end float of worm in housing			
Slew wheel bolts secured			
Slew guards secure			
<b>PLATFORM</b>			
Operation of control valve and buttons			
Operation of all booms over full range			
Cylinders are silent			
Platform levelling over full range			
Slewing smooth over full range			
Operation of boom 4 over full range (if fitted)			
<b>INTERNAL (POWER PACK)</b>			
Power pack and all components secure			
All cables and terminals secure			
All hose connections secure			
Hoses not kinked or fouled			
Charger/control box secure			
Battery secure			
Electrolyte level and specific gravity			
Charger operation			
Hydraulic oil level			
<b>FINISH</b>			
Operation of boom clamp			
Pivot pin tag bolts			
Correct decals, all visible			
Canopy/bonnets			
Grease nipples (Feet, Knuckle, Centre Post) (Tow coupling, Slew Gear, Boom 4-170)			
<b>LEAK CHECK</b>			
Cylinders (Lift, Jacks, Telescope, Levelling)			
Control valves			
Check valves			
Power pack/pump			
Slew motor			
Hose connections			

**Comments, remedial work required etc:**

**INSPECTED BY:** \_\_\_\_\_

**DATE:**     /     /0